

8FBE SERIES



Features and equipment may vary depending on market.

Best-in-class Energy Efficiency

High-efficiency New Motors and Motor-drivers
Newly developed motors and motor-drivers minimize the energy loss, and minimized heat generation greatly reduces energy consumption. This increases the operating time by 20%.

Operating Time
20% Increase

7h. 16min.
7FBE Series

8h. 47min.
8FBE Series

Comparison of operating times based on Toyota operating cycle for 1.5-ton with same battery capacity. Assuming that the forklift is actually operated in 55% of total working hours (100% discharge).



Features and equipment may vary depending on market.

Outstanding Visibility



Upward Visibility

A lattice-designed overhead guard provides good upward visibility.



Fork-tip Visibility

Equipped with small-diameter steering wheel, optimally positioned display, and an angled lower stay for the backrest gives excellent visibility of the fork tips.

Smooth Start Off on Slopes



Anti-rollback

When the accelerator or brake pedal is released while stopped on a grade, the forklift stops and then descends at a constant speed. This helps to ensure smooth operation on slopes.

SAS (System of Active Stability) - ε OPT



Helping to Prevent Load Spills

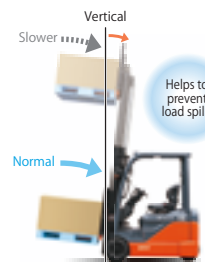

Active Mast Front-tilt Angle Control

The angle of forward mast tilt is automatically controlled to match the lift height and load weight, helping to prevent dropped loads or tip-over.

Active Mast Tilt Speed Control

Automatic control of mast tilt speed at high mast heights helps to prevent load spills.

Smooth Operation

Automatic Fork-leveling Control

Pressing a switch during forward tilt automatically stops the forks at a level position.



Smooth Travel

Active Steering Synchronizer

This feature ensures that the angle of the steering wheel invariably corresponds to the angle of the rear steered wheels.

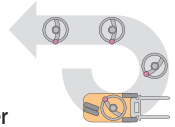

Stable Travel

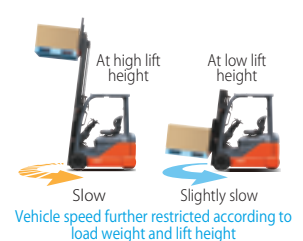
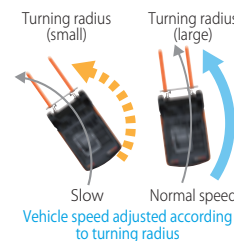

NEW Automatic Turn-speed Control

This controls speed according to the lift height, load weight, and turning radius, providing stable turning matched to the state of operation.

NEW Automatic Vehicle-speed Control

This controls vehicle speed as well as acceleration and deceleration according to lift height and load weight, helping to ensure stable travel and prevent load spills.

Robust Body Design



New Frame Design

The shape of the counterweight has been changed and its sides extended, to reduce the risk of collision damage during turns.

Energy Savings, Long Life LED Lights

These economical LED lights offer long life and low energy consumption. Also able to withstand jolts and vibration to a high degree, they are resistant to broken elements even when traveling on bumpy surfaces.



NEW LED Headlights OPT



NEW LED Rear Combination Lights OPT

NEW LED Rear Working Light OPT

NEW LED Yellow Beacon OPT



High Water Resistance (IPX4)

Through its structure and the layout of motors and controllers, the new 8FBE Series achieved high water resistance. Support for IPX4* enables to use at a wide range of worksites.

* According to internal research

For Safe Worksites



NEW Blue Light OPT

A blue beam of light appears on the ground to inform pedestrian of the forklift's presence, and helps prevent accidents.

Easy Battery Exchange



NEW Battery Side-out OPT

The battery with fork pockets can be taken out from the right side of the truck by using a forklift.

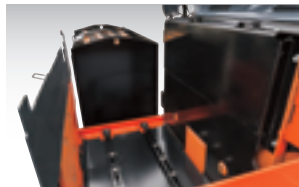

Battery Roll-out OPT

Exchange of the battery can be accomplished by extracting the battery by sliding it out.

Smooth Load Handling and Traveling Operation

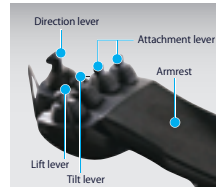

NEW Mini Lever OPT

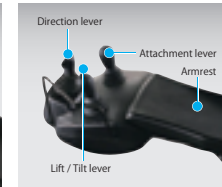

NEW Joystick OPT



NEW EZ Pedal OPT

MAIN SPECIFICATIONS

Model		8FBE10	8FBE13	8FBE15	8FBE18	8FBE20
Load Capacity	kg	1000	1250	1500	1750	2000
Load Center	mm	500	500	500	500	500
Overall Width	A mm	1075	1075	1075	1075	1075
Turning Radius (outside)	B mm	1385	1400	1515	1550	1675
Overhead Guard Height	C mm	1980	1980	1980	1980	1980
Length to Fork Face	D mm	1750	1755	1875	1905	2045

BATTERY AND MOTOR SPECIFICATIONS

Model			8FBE10	8FBE13	8FBE15	8FBE18	8FBE20
Voltage/Capacity (5-hour ratings)	Min.	V/Ah	48/280	48/280	48/390	48/390	48/390
	Max.	V/Ah	48/370	48/370	48/565	48/565	48/645
Electric Motors	Drive	kW	4.9×2	4.9×2	4.9×2	4.9×2	4.9×2
	Load Handling	kW	9.2	9.2	9.2	9.2	9.2
Energy Consumption (VDI Cycle)		kWh/h	3.2	3.3	3.5	3.8	4.0

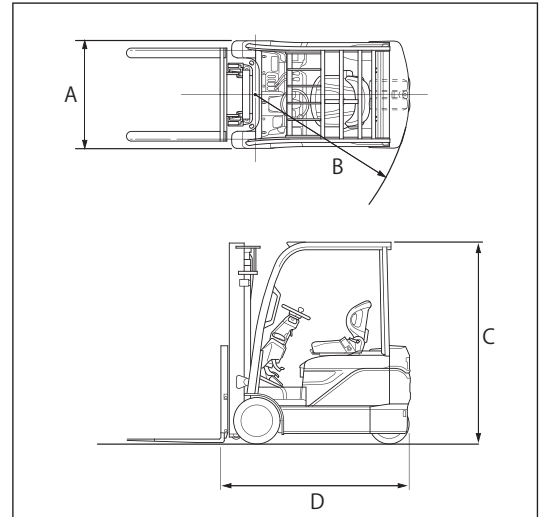

The data in this brochure was determined based on our standard testing condition. Operating performance may vary depending on the actual specifications and condition of the vehicle, as well as the conditions of the operating area.

Due to photography and printing, color of actual vehicle may vary from this brochure. Some photos have been computer-enhanced. Availability and specifications are determined regionally and are subject to change without notice.

Safe forklift operation is achieved by proper operator training and proper worksite rules. Please consult your Toyota representative regarding forklift selection and operator training. Please consult your Toyota representative for details.

All rights reserved by Toyota Industries Corporation.